

Vort Invisible Mini Range Commissioning Guide

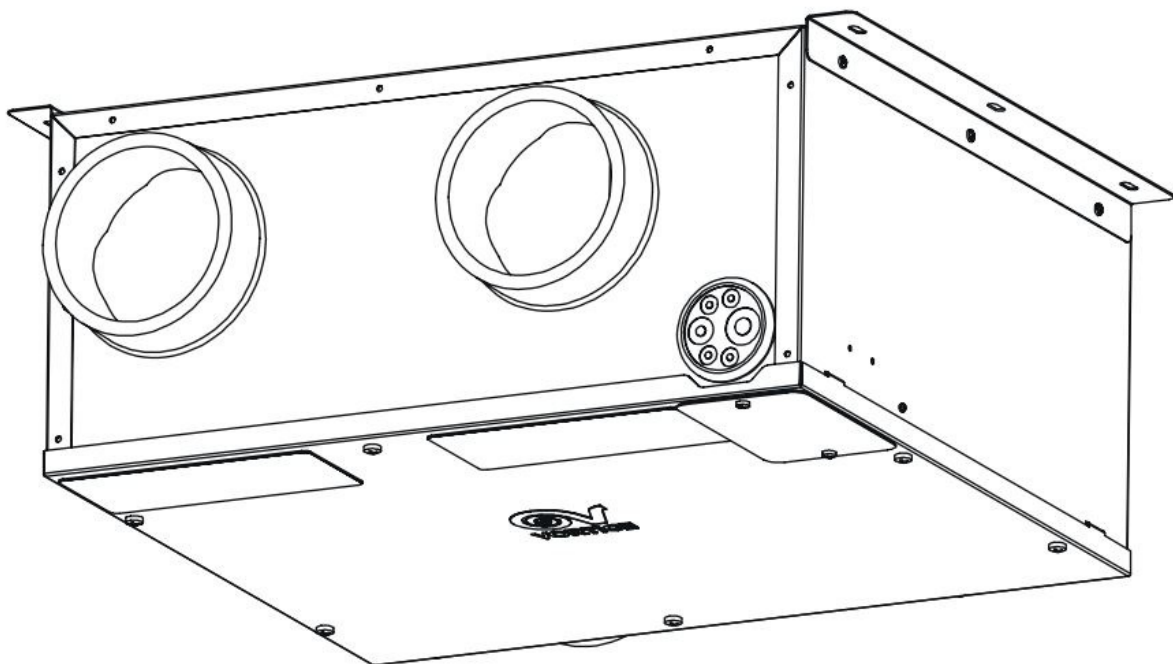

COD.UK.HR.MINI.00

23/09/2020

VORTICE LIMITED
Beeches House
Eastern Avenue
Burton on Trent
DE13 0BB
Tel. 01283 492949
Fax. 01283 544121
sales@vortice.ltd.uk
www.vortice.ltd.uk

Before installing and using your product, read these instructions carefully. Vortice will not accept any responsibility for damage to property or personal harm resulting from failure to abide by the conditions listed below.

Following these instructions will ensure long service life and overall electrical and mechanical reliability. Keep this instruction booklet in a safe place for reference purposes.

Commissioning the Vort Invisible Mini

Before commencing the commissioning process make sure you have the correct system design air flow calculations for the property. These should show the air flows for each room at both the low rate (trickle) and the high rate (boost).

If these are unavailable you will need to calculate these by using the appropriate building regulations for the geographic location of the dwelling. (England & Wales: Approved Document F 2010. Scotland: Standard 3.14 Ventilation, technical Handbook- Domestic – Environment (2015))

England & Wales: Approved Document F 2010 (ADF2010)

Calculating the Whole Dwelling Ventilation Rate (Trickle rate)

The low rate is calculated by taking the higher of two below calculations.

1. Calculate the floor area in m² of the heated envelop of the dwelling then multiply this by 0.3l/s (Litres per Second) to give the trickle rate in (l/s) for the whole dwelling.

$$\text{m}^2 \text{ floor area} \times 0.3\text{l/s} = \text{trickle rate in l/s}$$

2. Calculate the total amount of occupants for the dwelling by using table 5.1b in ADF2010. Reference the number of bedrooms in the dwelling to the whole dwelling ventilation rate on table 5.1b, remember to add any additional occupants in the additional bedrooms after the first, by adding 4l/s per additional occupant.

	Number of bedrooms in dwelling				
	1	2	3	4	5
Whole dwelling ventilation rate ^{a, b} (l/s)	13	17	21	25	29

Notes:

a. In addition, the minimum ventilation rate should be not less than 0.3 l/s per m² of internal floor area. (This includes all floors, e.g. for a two-storey building add the ground and first floor areas.)

b. This is based on two occupants in the main bedroom and a single occupant in all other bedrooms. This should be used as the default value. If a greater level of occupancy is expected add 4 l/s per occupant.

3. Take into account the infiltration allowance of the dwelling as defined in table 5.1d of ADF2010. If the dwelling designed air permeability is greater (>) than 5m³(h.m²) at 50Pa, the calculated trickle rate is reduced by the value calculated from table 5.1d ADF2010 to take into account the natural infiltration of the dwelling.

Table 5.1d (ADF2010)

Design of MVHR systems

System 4 has been sized for the winter period. Additional ventilation may be required during warmer months and it has been assumed that the provisions for *purge ventilation* (e.g. openable windows) could be used.

Step 1: For any design *air permeability*, determine the *whole dwelling ventilation* supply rate from Table 5.1b.

As an alternative where the designed *air permeability* is intended to be leakier than (>) 5 m³/(h.m²) at 50 Pa, allow for infiltration for all dwelling types by subtracting from the *whole dwelling ventilation* supply rate from Table 5.1b: 0.04 l/(s.m³) x *gross internal volume* of the dwelling heated space (m³), but see the cautionary advice in 5.10.

If the designed air permeability rate of the dwelling is less than 5m³(h.m²) at 50Pa then no deduction is made to the original trickle rate for the infiltration allowance.

This volumetric airflow needs to be split proportionately by room size of the habitable rooms within the dwelling.

Calculating the High Rate (Boost)

The high rate is calculated by adding the Minimum high rate for each of the wet rooms within the dwelling (kitchen, bath, utility etc.) together from the values in table 5.1a in ADF2010 continuous extract.

Table 5.1a Extract ventilation rates			
Room	Intermittent extract		Continuous extract
	Minimum rate	Minimum high rate	Minimum low rate
Kitchen	30 l/s adjacent to hob; or 60 l/s elsewhere	13 l/s	Total extract rate should be at least the <i>whole dwelling ventilation</i> rate given in Table 5.1b
Utility room	30 l/s	8 l/s	
Bathroom	15 l/s	8 l/s	
Sanitary accommodation	6 l/s	6 l/s	

Note. If the calculated trickle rate as defined by ADF (Table 5.1b) and taking into account the infiltration allowance (as defined in Table 5.2d) is greater than the total boost rate (as defined in Table 5.1a continuous extract) the boost is taken as being equal to the trickle rate, as the trickle rate is greater than the minimum high rate / boost.

This volumetric airflow needs to be split proportionately by room type as in Table 5.1a continuous extract and achieving the minimum high rates as defined.

Scotland: Standard 3.14 Ventilation, Technical Handbook – Domestic – Environment (2015)

(Also Building Standards Supporting Guidance Domestic Ventilation 2rd Edition)

Calculating the Whole Dwelling Ventilation Rate (trickle rate)

1. Calculate the volume of the heated envelope of the dwelling in cubic metres and then calculate the air volume at 0.5 Air Changes Per Hour (ACPH). This will give the required rate in metres cubed per hour (m³/h). To convert this value to litres per second (l/s) divide by 3.6.

$$\text{m}^3 \text{ of dwelling} \times 0.5 \text{ ACPH} = \text{Low rate in m}^3/\text{h}$$

$$\text{Low rate in m}^3/\text{h} / 3.6 = \text{Low rate in l/s}$$

This volumetric airflow needs to be split proportionately by room size of the habitable rooms within the dwelling.

Example Ventilation Solution 4: - Continuously Operating Balanced Supply and Extract (with or without Heat Recovery)

	Apartment	Kitchen	Bathroom / Shower	Toilet	Utility Room
Openable Ventilator	1/30 th floor area ^[1]			1/30 th floor area ^[1]	
Trickle Ventilator	N/A	N/A	N/A	N/A	N/A
Continuously Operating Mechanical Extract ^[2]	0.5 ACPH minimum	0.5 ACPH Minimum and 25 -50 % boost	0.5 ACPH minimum and 25 -50 % boost	0.5 ACPH minimum	0.5 ACPH minimum

Note:

[1] Openable ventilators (generally windows) provide summer cooling, rapid ventilation and for use when mechanical system switched off.

[2] Based on whole house ventilation rate.

Calculating the High Rate (boost)

The boost is calculated at a minimum of +25% of the low rate and a maximum of 50% of the trickle rate.

$$\text{Low rate in m}^3/\text{h} + 25\% = \text{High rate (boost) in m}^3/\text{h}$$

or

$$\text{Low rate in l/s} + 25\% = \text{High rate (boost) in l/s}$$

This volumetric airflow needs to be split proportionately by room size of the wet rooms within the dwelling.

Controller Overview

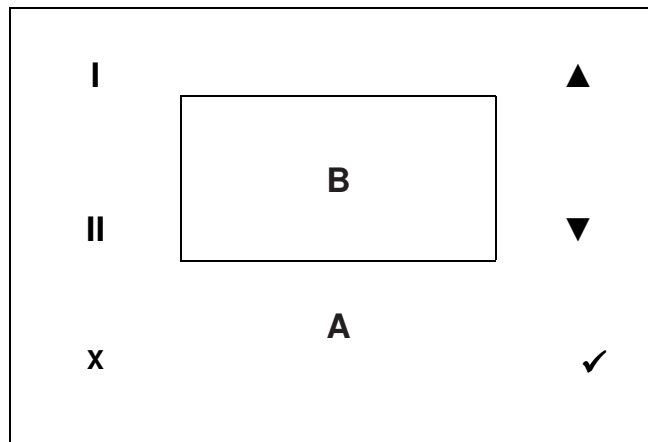

A Touch pad area

B Display

Key	Function
▲	To select the fan high speed (Boost) To move up through menu lists To increase a value in a selected menu
▼	To select the fan low speed (Normal) To move down through menu lists To decrease a value in a selected menu
I	Screen 1 showing date and time
II	Screen 2 showing system temperatures
x	Exit and return to previous screen without saving
✓	Confirm / save current setting

Vort Invisible Mini Commissioning Process

A: Preparation for Commissioning.

- A1. Close all doors and windows.
- A2. Open all the duct valves to the fully open position.

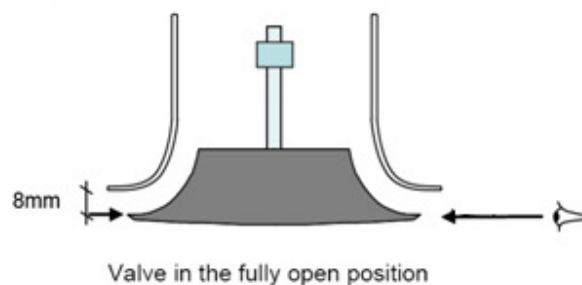

- A3. Have the system calculations for the dwelling handy. (Tip: write the value for each room clearly on a piece of paper and leave in each room for handy reference).

B: Setting the Whole Dwelling Ventilation Rate (Trickle)

- B1. Set the Anemometer for measuring supply air flow.
- B2. Make sure the unit is set on the low speed (showing Normal on the display) and all boost switches are in the off position.
- B3. Set the low speed (trickle) on the unit by adjusting the low speed fan setting so that the total of all the supply valves is equal to or just over the required rate.
- B4. Adjusting the fan speed: the fan speed for the supply fan (VI1 & VI2) and extract fan (VO1 & VO2) will need to be set individually.

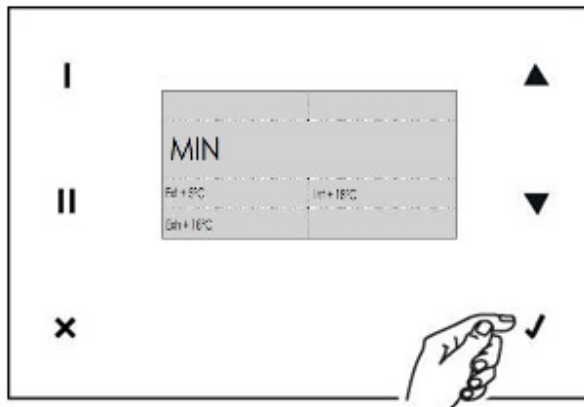

- B5. Press the “X” a couple of times to make sure you are at the main display screen.
- B6. Press the “✓” to display main menu screen.

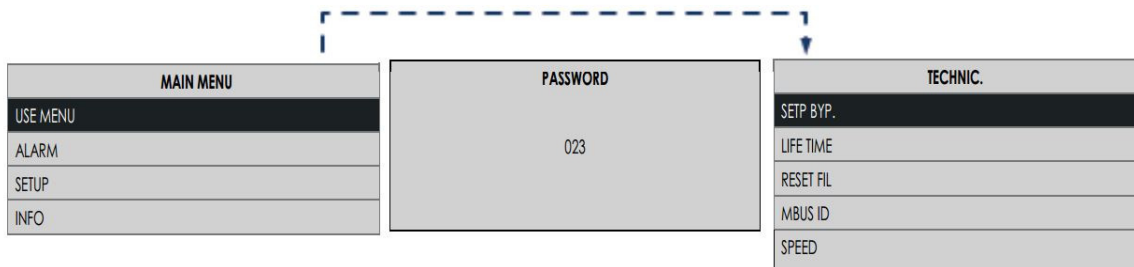

- B7. Use the “▲ & ▼” to select “USE MENU” then press the “✓” to select.
- B8. “000” will be displayed. Use the “▲” to enter the password 023 then “✓” to enter.
- B9. Use the “▲ & ▼” to select “SPEED” then press the “✓” to select.
- B10. Select the speed to be adjusted using the “▲ & ▼” then press the “✓”.
- VI1 = Supply Background (Trickle) rate (Habitable rooms)
VO1 = Extract Background (Trickle) rate (Wet Rooms)
 VI2 = Supply High (Boost) rate (Habitable rooms)
VO2 = Extract High (Boost) rate (Wet Rooms)

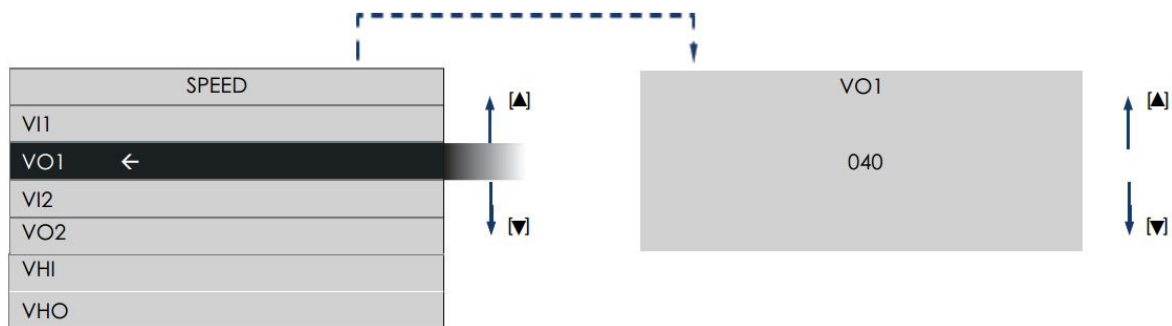

B11. Select VI1 (Trickle supply to habitable rooms) using the “▲ & ▼” keys then press the “✓”.

The speed setting is displayed; using the “▲ & ▼” keys adjust the fan speed until the required setting to achieve the total air flow rate (on trickle) is reached and then press the “✓” to select and enter the speed.

B12. Measure the total supply air at the supply valves and repeat step B11 until the required air flow rate or just above is reached.

B13. Now adjust the individual supply valves until each room is receiving the correct air flow. You may need to adjust the fan speed during this process to compensate for any additional resistance.

B14. Select VO1 (Boost to habitable rooms) using the “▲ & ▼” keys then press the “✓”.

The speed setting is displayed; using the “▲ & ▼” keys adjust the fan speed until the required setting to achieve the total air flow rate (on boost) is reached and then press the “✓” to select and enter the speed.

B15. Measure the total supply air at the supply valves and repeat step B14 until the required total air flow rate or just above is reached. **DO NOT adjust the ceiling valves.**

C: Setting the Maximum Extract Ventilation Rate (Boost)

- C1. Set the Anemometer for measuring extract air flow.
- C2. Keep the unit set on the low speed (showing Normal on the display) and all boost switches are in the off position.
- C3. Set the high speed (boost) on the unit by adjusting the high speed fan setting so that the total of all the extract valves is equal to or just over the required rate.
- C4. Press the “X” a couple of times to make sure you are at the main display screen.
- C5. Press the “✓” to display menu screen.

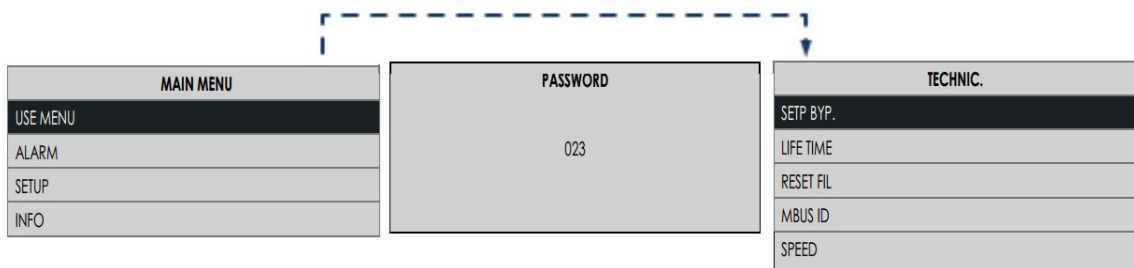

- C6. Use the “▲ & ▼” to select “MAIN MENU” then press the “✓” to select.
 - C7. “000” will be displayed. Use the “▲” to enter the password 023 then “✓” to enter.
 - C8. Use the “▲ & ▼” to select “SPEED” then press the “✓” to select.
 - C9. Select the speed to be adjusted using the “▲ & ▼” then press the “✓”.
- VI1 = Supply Background (Trickle) rate (Habitable rooms)
VO1 = **Extract Background (Trickle) rate (Wet Rooms)**
VI2 = Supply High (Boost) rate (Habitable rooms)
VO2 = **Extract High (Boost) rate (Wet Rooms)**

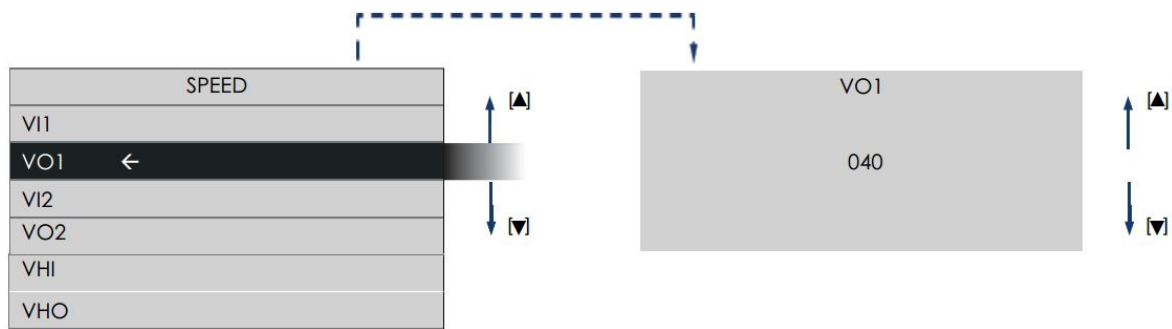

- C10. Select VO2 (Boost extract from the wet rooms) using the “▲ & ▼” keys then press the “✓”.

The speed setting is displayed; using the “▲ & ▼” keys adjust the fan speed until the required setting to achieve the total air flow rate (on boost) is reached and then press the “✓” to select and enter the speed.

- C11. Measure the total extract air at the extract valves and repeat step C10 until the required air flow rate or just above is reached.

- C12. Now adjust the individual extract valves until each room is extracting the correct air flow. You may need to adjust the fan speed during this process to compensate for any additional resistance.

- C13. Select VO1 (Trickle from the wet rooms) using the “▲ & ▼” keys then press the “✓”.

The speed setting is displayed; using the “▲ & ▼” keys adjust the fan speed until the required setting to achieve the total air flow rate (on trickle) is reached and then press the “✓” to select and enter the speed.

- C14. Measure the total extract air flow at the extract valves and repeat step C13 until the required total air flow rate or just above is reached. **DO NOT adjust the ceiling valves.**

D: Setting the Bypass Trigger Temperature

- D1. Press the “x” a couple of times to make sure you are at the main display screen.
- D2. Press the “✓” to display menu screen.

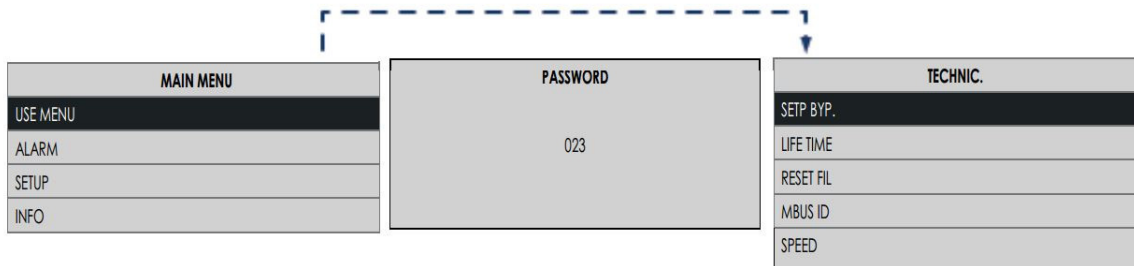

- D3. Use the “▲ & ▼” to select “MAIN MENU” then press the “✓” to select.
- D4. “000” will be displayed. Use the “▲” to enter the password 023 then “✓” to enter.
- D5. Use the “▲ & ▼” to select “SETUP BYP” then press the “✓” to select.

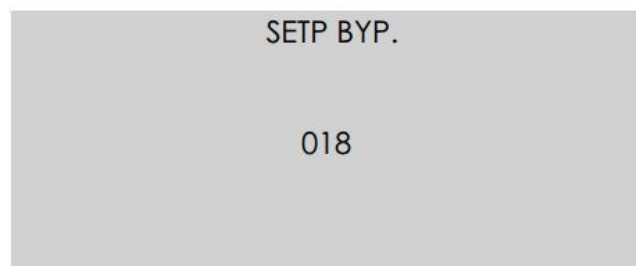

- D6. The default value of “018” (18 degrees centigrade) will be displayed. Use the “▲ & ▼” to set the point at desired temperature to activate the bypass, then press the “✓” to enter. Can be set between 15° and 30°.
- D7. Press the “x” a couple of times to return to the main display screen.

E: Setting the Filter Lifetime

- E1. Press the “X” a couple of times to make sure you are at the main display screen.
- E2. Press the “✓” to display menu screen.

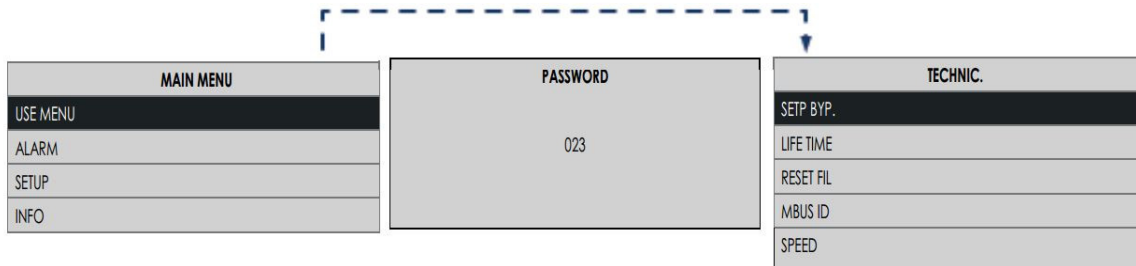

- E3. Use the “▲ & ▼” to select “MAIN MENU” then press the “✓” to select.
- E4. “000” will be displayed. Use the “▲” to enter the password 023 then “✓” to enter.
- E5. Use the “▲ & ▼” to select “LIFE TIME” then press the “✓” to select.

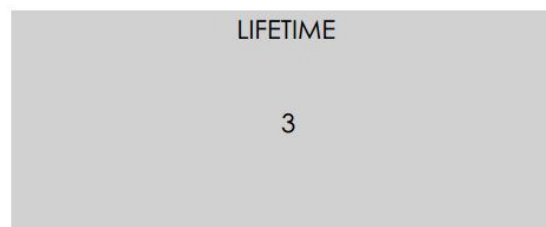

- E6. Use the “▲ & ▼” to select time duration for filter cleaning / replacement alarm indication. This can be set at 3 (default) 6 or 12 months, then press the “✓” to select.

F: Setting & Programming the Quiet Mode

Fa: Setting the Quiet Mode

Fa1. Press the “X” a couple of times to make sure you are at the main display screen.

Fa2. Press the “✓” to display menu screen.

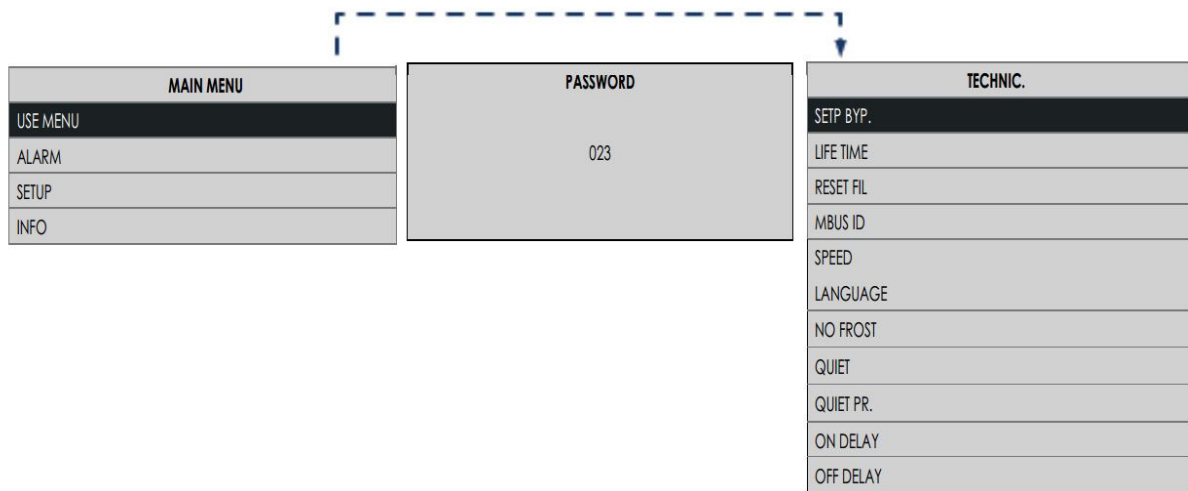

Fa3. Use the “▲ & ▼” to select “MAIN MENU” then press the “✓” to select.

Fa4. “000” will be displayed. Use the “▲” to enter the password 023 then “✓” to enter.

Fa5. Use the “▲ & ▼” to select “QUIET” then press the “✓” to select.

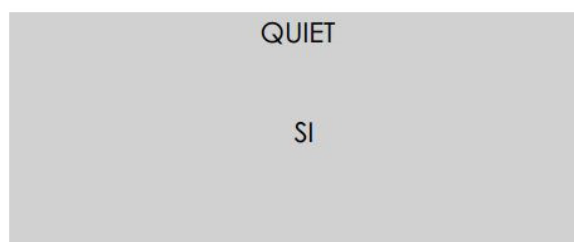

Fa6. Use the “▲ & ▼” to select “SI / YES” or “No” then press the “✓” to select.

Fb: Setting the Quiet Mode

Fb1. Press the “X” a couple of times to make sure you are at the main display screen.

Fb2. Press the “✓” to display menu screen.

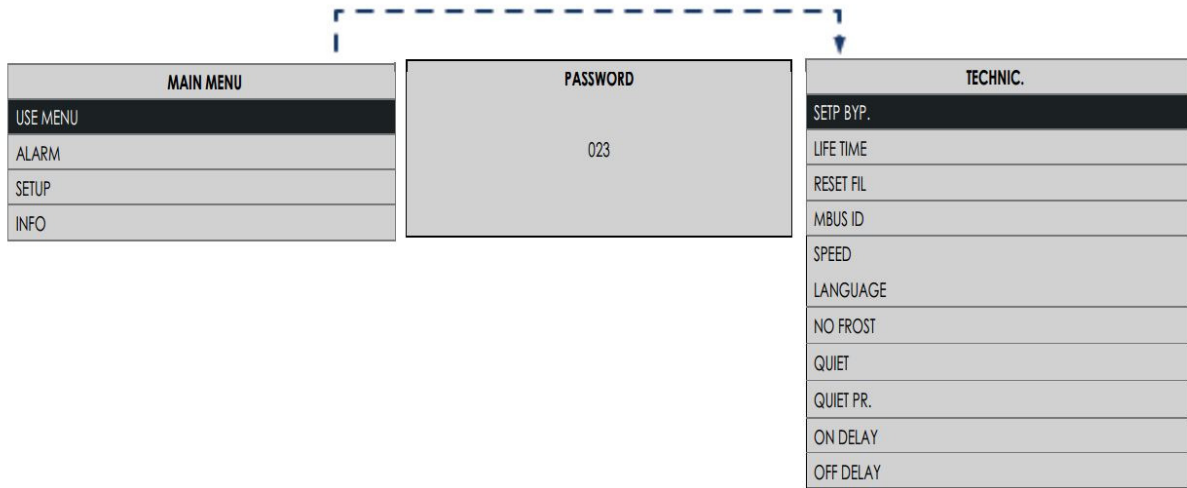

Fb3. Use the “▲ & ▼” to select “MAIN MENU” then press the “✓” to select.

Fb4. “000” will be displayed. Use the “▲” to enter the password 023 then “✓” to enter.

Fb5. Use the “▲ & ▼” to select “QUIET PR” then press the “✓” to select.

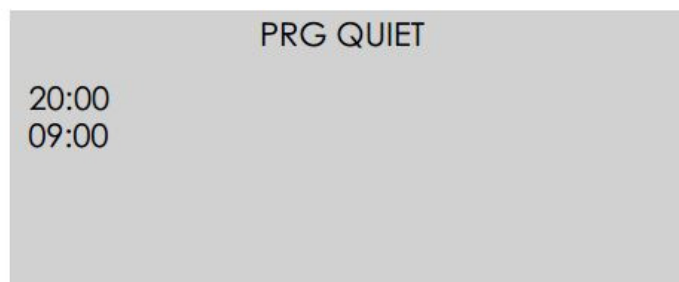

Fb6. Use the “▲ & ▼” to select the start time (top) and end time (bottom) then press the “✓” to select. The unit will operate in quiet mode between these times.

G: Setting the Delay Boost On

- G1. Press the “x” a couple of times to make sure you are at the main display screen.
- G2. Press the “✓” to display menu screen.

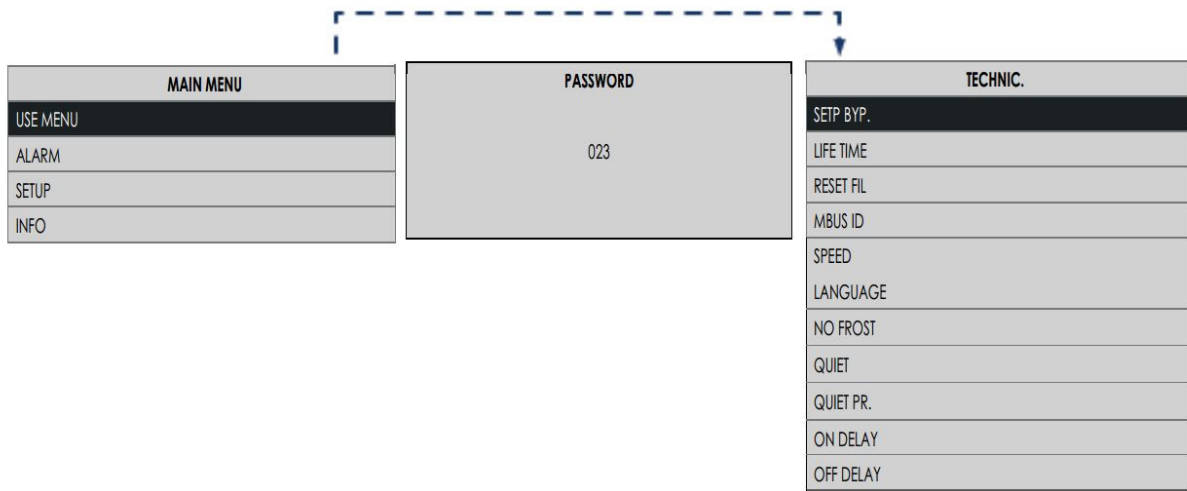

- G3. Use the “▲ & ▼” to select “MAIN MENU” then press the “✓” to select.
- G4. “000” will be displayed. Use the “▲” to enter the password 023 then “✓” to enter.
- G5. Use the “▲ & ▼” to select “ON DELAY” then press the “✓” to select.

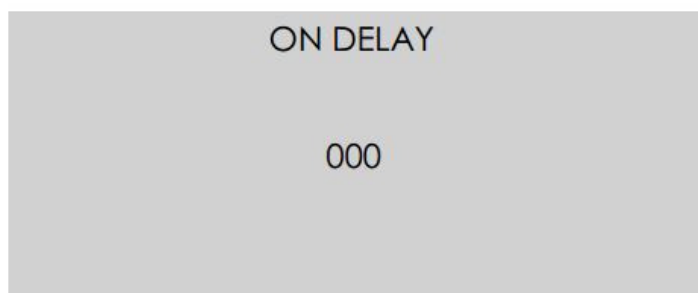

- G6. Use the “▲ & ▼” to select “000” for no delay in starting the boost speed or “2:00” for a 2 minute delay before starting boost speed, then press the “✓” to select.

H: Setting the Delay Boost On

- H1. Press the “X” a couple of times to make sure you are at the main display screen.
- H2. Press the “✓” to display menu screen.

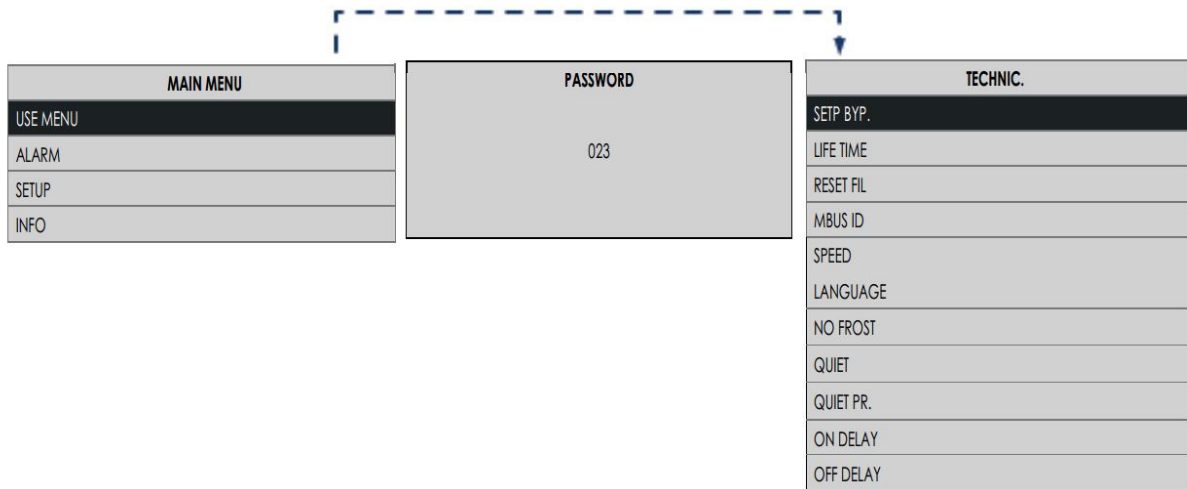

- H3. Use the “▲ & ▼” to select “MAIN MENU” then press the “✓” to select.
- H4. “000” will be displayed. Use the “▲” to enter the password 023 then “✓” to enter.
- H5. Use the “▲ & ▼” to select “OFF DELAY” then press the “✓” to select.

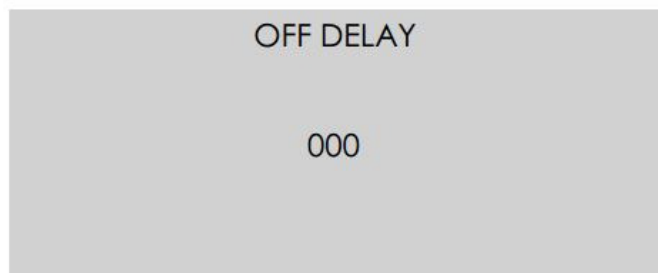

- H6. Use the “▲ & ▼” to select the length of the overrun timer for the boost speed “000” for no overrun time. Max overrun is 20 minutes settable in 1 minute steps, press the “✓” to select.