

UVLOGIKA SYSTEM RANGE



Germicidal
UV-C lamp





VORTICE S.p.A. is part of a multinational group, **VORTICE GROUP**, which operates through its own companies or local distributors in over 90 countries worldwide and has a rich product portfolio that guarantees air quality and climate comfort. The headquarters of VORTICE S.p.A are in Tribiano (Milan).



VORTICE GROUP also includes:

[1]
VORTICE LIMITED, the UK subsidiary of VORTICE S.p.A., established in 1977 and based in Burton on Trent.

[2]
VORTICE INDUSTRIAL, born from the acquisition in 2010 of Loran srl, based in Isola della Scala (VR).

[3]
VORTICE VENTILATION SYSTEM, a company inaugurated in 2013 with headquarters in Changzhou, China.

[4]
VORTICE LATAM S.A., based in Alajuela in Costa Rica, established in 2012.

[5]
CASALS VENTILACIÓN AIR INDUSTRIAL S.L., historic Spanish brand, based in Sant Joan de les Abadesses, Girona, acquired in 2019.

ENVIRONMENTAL SANITISERS

Correct ventilation of the rooms with frequent air changes facilitates the removal of pollutants, preventing their accumulation in high concentrations and therefore preserving the safety of the occupants.

However, the only introduction of fresh air, while significantly thinning out the pollutants present in the air of the rooms, has no effect on the surfaces on which pathogens can deposit themselves and proliferate.

Therefore, SANITISING the surfaces with which we can come into contact every day at home, in the office or in any other closed space, is essential for the health of all those who live and work there.

Certifications

The UVLOGIKA SYSTEM complies with the following Directives and Regulations in their latest version:

- Low Voltage Directive: 2014/35/CE;
- Electromagnetic Compatibility Directive: 2014/30/CE;
- General Standard for Lighting Fixtures: EN 60598;
- Photo-biological safety of lamps and lamp systems: EN 62471;
- Electrical Safety Regulations: EN 62233;
- Electromagnetic Compatibility Emission Standard: EN 55014-1;
- Standard Limits for harmonic current emission for equipment with input current less than or equal to 16A: EN 61000-3-2;
- Standard Limitation of voltage fluctuations and flicker for equipment with rated current lower than or equal to 16A: EN 61000-3-3;
- Standard Microbiology of the food chain - Horizontal methods for surface sampling: EN ISO 18593;
- Standard Microbiology of the food chain - Horizontal method for the enumeration of microorganisms - Part 2: Colony count at 30 °C using the surface plating technique: EN 4833-2.

UVLOGIKA SYSTEM RANGE

Germicidal UV-C lamp.

The UVLOGIKA SYSTEM is an installation lamp designed to irradiate UV-C ultraviolet light at a constant wavelength of 254 nm.

The UVLOGIKA SYSTEM is ideal for sanitising surfaces by eliminating bacteria, viruses, molds, germs or pathogens, without any emission of ozone. The system is safer and with the lowest environmental impact.

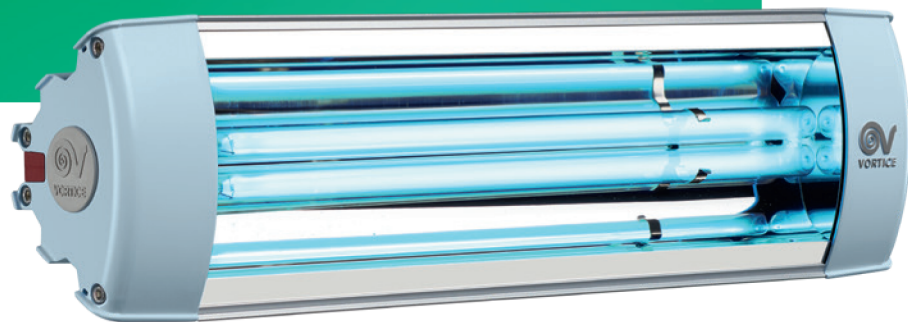

Design by
DANIEL PIVA

USE

UVLOGIKA SYSTEM is particularly suitable for the disinfection of surfaces in domestic, commercial or industrial environments. The radiation from the lamp quickly eliminates up to **99% of bacteria, viruses and other microorganisms**. Fundamental to operate it safely is to make it work in the absence of people and animals.

Typically used, for example, in offices, waiting rooms, bars, restaurants, bathrooms (zone 3 in accordance with the standard for electrical systems CEI 64-8/7), classrooms, places of worship, meeting rooms, etc.



BENEFIT FOR THE INSTALLER

01 Simple and quick installation

UVLOGIKA SYSTEM in a **horizontal or vertical position, can be installed on the ceiling or on the wall by means of the special bracket (supplied)**, which allows it to be oriented according to the most suitable angle and considering the position of the surfaces to be sanitised.

02 Wide configurability

The **numerous accessories available** as an option make UVLOGIKA SYSTEM extremely versatile and capable of satisfying the surface sanitising needs of a wide range of environments in multiple contexts.

03 Wide range of possible installations

Its small size makes UVLOGIKA SYSTEM the ideal product for sanitizing office surfaces, professional environments, classrooms and more generally premises that are **open to the public and unattended during certain periods of the day.**



BENEFIT FOR THE USER

01

Immediate effectiveness

The germicidal action exerted by UVLOGIKA SYSTEM takes place in a relatively short time; sanitised objects and, more generally, **surfaces are immediately usable from the moment the lamp is turned off**. A special electronic device (ballast), integrated in the product, ensures a constant wavelength of the emitted radiation, ensuring the effectiveness of the germicidal action over time.

02

High efficiency

UVLOGIKA SYSTEM emits UV-C rays with a wavelength calibrated at 254 nm, acting in a short time on 99.9% of microorganisms.

03

Environmental sustainability (OZON FREE)

UVLOGIKA SYSTEM effectively sanitises surfaces without releasing any chemical into the atmosphere.

04

Safety of use

UVLOGIKA SYSTEM is fully compliant with the applicable safety standards relating to lighting equipment. Moreover, the combination with devices such as PIR SYSTEM or C PIR prevents the risk of exposing people or animals to radiation, fully protecting their health, and the UV-C adopted does not emit ozone.

05

Continuous sanitisation of the premises

The combination with PIR SYSTEM or C PIR makes UVLOGIKA SYSTEM particularly suitable for the continuous disinfection of premises frequented by the public throughout the day, such as the toilets of service stations, railway stations, airports, etc....

06

Comfort of use

The UV-C radiation is odorless, does not involve the emission of gas or other compounds harmful to health and does not create polluted air flows when used in dusty environments.

07

Long life

The robust structure of the aluminum casing and the high quality of the UV-C lamp that equips UVLOGIKA SYSTEM ensure its regular operation over time.

08

Low operating costs

The low consumption (36W) and the long life of the UV-C lamp (9,000 h nominal) that equips UVLOGIKA SYSTEM are fully compatible with a prolonged use of the product.

09

Speed

Extreme speed of continuous sanitisation of the premises.

APPLICATIONS



Shops and commercial activities

8



Offices, meeting rooms and professional studios

Restaurants, bars and canteens



Airports and stations



APPLICATIONS

Common rooms and waiting rooms



10

Universities, schools
and kindergartens





Beauty centers,
hairdressers and SPAs



Gyms and changing rooms

TECHNICAL CHARACTERISTICS

Available models

- 1 model available: **UVLOGIKA SYSTEM (code 70014)** which has a constant wavelength of 254 nm.

Casing

- Anodised extruded aluminum casing, which combines excellent aesthetics with the necessary mechanical resistance, while giving the product high installation flexibility, thanks to the 5 rear horizontal grooves, useful for orienting the device in the most appropriate way according to the installation type.
- Side panels in die-cast aluminum coated with polyester paint: they combine fine aesthetic with high mechanical and thermal resistance.

Reflector

- In the development of UVLOGIKA SYSTEM, particular attention has been paid to the design of the reflector, which plays an essential role in terms of sanitising efficacy.
- The reflector is made of polished, anodised and Al/SiO₂ coated aluminum sheet (Aluminum/Silicon), applied with the PVD process (Physical Vapor Deposition). The treatment adopted accentuates the already high intrinsic reflectance characteristics of aluminum, reaching average values higher than > 90%. This result, combined with accurate photometric studies conducted on the geometry of the component, guarantees a very high and homogeneous concentration of UV-C radiation, so as to maximise its sanitising effect.

Supplied accessories

- Bracket for wall and ceiling attachment, in folded sheet metal, ensures the firm fixing of the product to the wall or ceiling. The coupling mechanism makes it possible to adjust the angle of inclination according to the relative position of the surfaces to be sanitised.

UV-C Lamp

- The UV-C lamp that equips the UVLOGIKA SYSTEM radiates ultraviolet rays with a wavelength of 254 nm, effective against allergens and pathogenic microorganisms such as mold, bacteria and viruses.
- The internal protective coating maintains the effectiveness of the germicidal radiation unaltered over time. The mercury vapor fluorescent light bulb is characterised by a very low (few mg) content of mercury (Hg). The glass of the casing filters the ozone, preventing its emission into the environment.
- A special transformer, called ballast, housed in the casing ensures the constant flow of electricity and keeps the wavelength constant, avoiding power fluctuations that could reduce the effectiveness of the disinfection process. The ballast mounted on the UVLOGIKA SYSTEM is able to always provide an optimal and continuous input to the lamp, which therefore has a long life (9000h).
- The power of the lamp, equal to 36W, ensures a radiation intensity equal to 110 [$\mu\text{W}/\text{cm}^2$], perfectly suited to the application.

Sturdy structure

Precious materials have been chosen for the development of the product, which do not change their characteristics over the time, and are extremely robust from the thermal stress standpoint.

Maximum silence,

given the absence of moving parts.

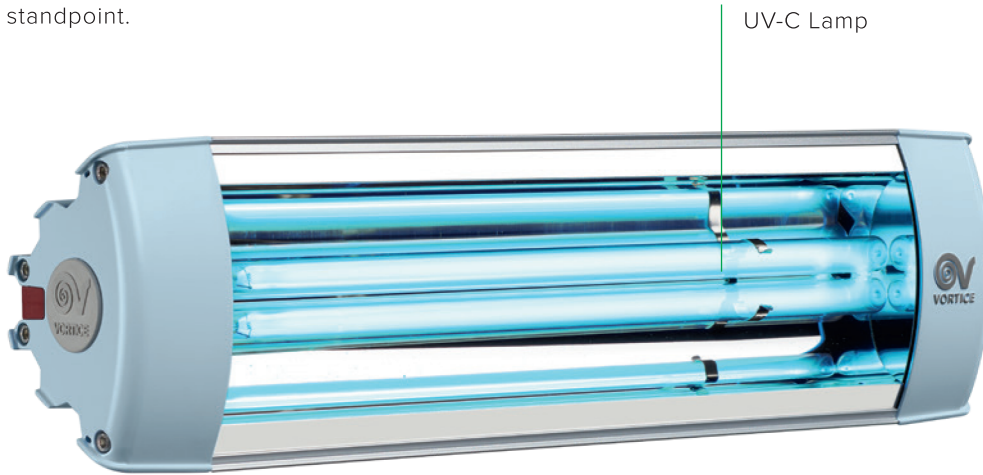

UV-C Lamp

The 5 grooves on the back of the UVLOGIKA SYSTEM make it possible to change the angle of inclination of the installed product and optimise the orientation of the irradiated flow.

Power cable,
2 meters long.

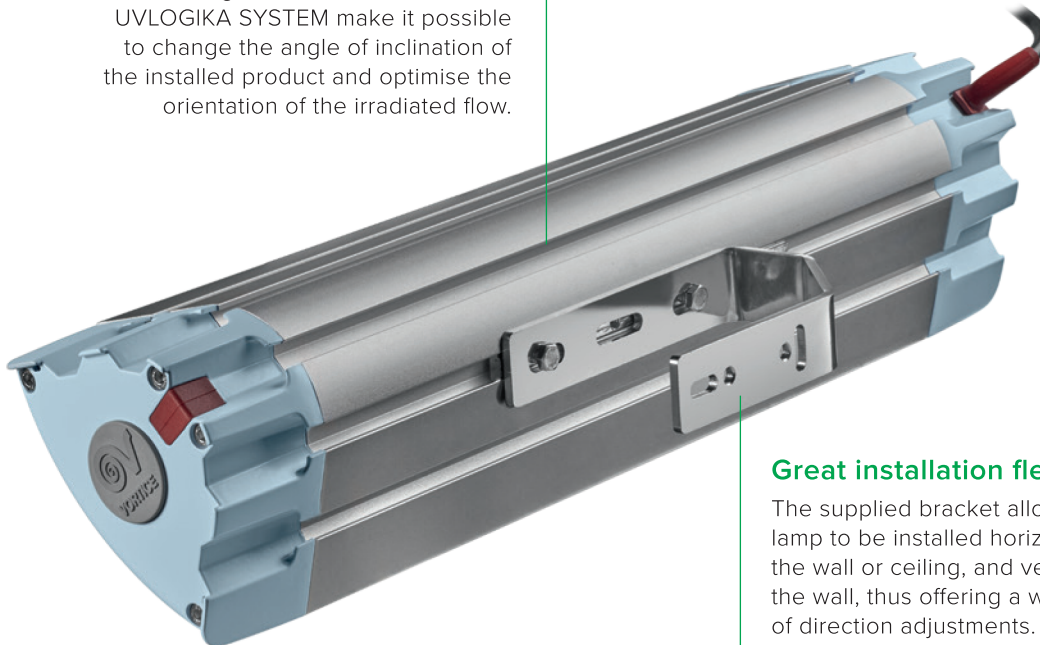

Great installation flexibility

The supplied bracket allows the lamp to be installed horizontally, on the wall or ceiling, and vertically on the wall, thus offering a wide range of direction adjustments.

Multiple mounting options

A wide range of accessories allows the UVLOGIKA SYSTEM to be mounted on ceilings and walls.

TECHNICAL DATA

POWER SUPPLY	220-240 V~50/60 Hz
MAX ABSORPTION	36 W
MAX ABSORBED CURRENT	0.2 A
WAVELENGTH	254 nm
EMISSION ANGLE	110°
UV-C POWER	12 W
UV-C RADIANT POWER	8.4 W
EFFECTIVE IRRADIANCE (D=1 m)	220 [μ W/cm ²] (2.2 W/m ²)
OZONE EMISSION	None
LAMP LIFE	9000 h

SANITISING EFFICACY OF UVLOGIKA SYSTEM

The germicidal efficacy of a UV-C radiation depends on numerous factors: the constancy of the wavelength, the radiation power, the distance of the source from the radiated surface and the radiation time.

Tests carried out by a UNI CEI EN ISO/IEC 17025:2018 accredited laboratory demonstrate the effectiveness of UVLOGIKA SYSTEM on a wide range of bacteria, viruses and other microorganisms.

The ballast in UVLOGIKA SYSTEM ensures a constant wavelength on the optimal value of 254 nm, avoiding oscillations that could limit the effectiveness of the device.

The power of UVLOGIKA SYSTEM, equal to 36W, ensures a radiation intensity, equal to the radiated power by the exposure time, of 220 μ W/cm².

This value is sufficient to eliminate, in just 8 minutes of exposure, 99% of the bacteria and viruses listed in the table on the side (in bold) and present on a surface located 2 m from the lamp.

In the following pages, different examples of surface sanitisation are reported to better understand about the lamp efficacy in function of exposure time and distance from surface.

Further information regarding the efficacy of UVLOGIKA SYSTEM can be obtained by writing to the VORTICE Presale Service at the address: pre-sales@vortice-italy.com.

Post script: During the installation phase, it is strongly recommended to use the UVLOGIKA SYSTEM in combination with a suitable timer in order to program its switch on in the time slots, where there is an effective need for sanitization, this to avoid the risk of accidental exposure and to increase the lifetime of the lamp.

Table UV-C rays DOSE* to eliminate 99% of microorganisms

BACTERIA	DOSE (J/M ²)	YEASTS	DOSE (J/M ²)
BACILLIUS ANTHRACIS	87	BREWERS YEAST	66
B. MEGATHERIUM SP. (SPORES)	52	COMMON YEAST CAKE	132
B. MEGATHERIUM SP. (VEG)	25	SACCHAROMYCES CEREVISIAE	132
B. PARATHYPHOSUS	61	SACCHAROMYCES ELLIPSOIDEUS	132
B. SUPTILLIS	110	SACCHAROMYCES SP.	176
B. SUPTILLIS SPORES	220		
CLOSTRIDIUM TETANI	220	MOLD SPORES	DOSE (J/M ²)
CORYNEBACTERIUM DIPHTERIAE	65	ASPERGILLUS FLAVUS	990
DYSENTERY BACILLI	41	ASPERGILLUS GLAUCUS	880
ESCHRICHIA COLI	66	ASPERGILLUS NIGER	3300
MICROCOCCUS CANDIDUS	123	MUCOR RACEMOSUS A	352
MICROCOCCUS SPHAEROIDES	154	MUCOR RACEMOSUS B	352
MYCOBACTERIUM TUBERCULOSIS	100	OOSPORA LACTIS	110
NEISSERIA CATARRHALIS	85	PENICILLIUM DIGITATUM	880
PHYTOMONAS TUMEFACIENS	80	PENICILLIUM EXPANSUM	220
PSEUDOMONAS AERUGINOSA	105	PENICILLIUM ROQUEFORTI	264
PSEUDOMONAS FLUORESCENT	66	RHIZOPUS NIGRICANS	2200
PROTEUS VULGARIS	66		
SALMONELLA ENTERITIDIS	76	VIRUSES	DOSE (J/M ²)
SALMONELLA PARATYPHI	61	SARS-COV-2 (COVID-19)	220
SALMONELLA TYPHIMIRIUM	152	HEPATITIS A	80
SARCINA LUTEA	264	FLU VIRUS	66
SERATIA MARCESCENS	62	POLIO VIRUS	66
SHIGELLA PARADYSENTERIAE	34	BACTERIOPHAGE - E. COLI	66
SPIRILLUM RUBRUM	62		
STAPHYLOCOCCUS ALBUS	57	PROTOZOA	DOSE (J/M ²)
STAPHYLOCOCCUS AUREUS	66	CHLORELLA VULGARIS	220
STREPTOCOCCUS HEMOLUTICUS	55	NEMATODE EGGS	920
STREPTOCOCCUS LACTUS	88	PARAMECIUM	220
STREPTOCOCCUS VIRIDANS	38		
VIBRIO CHLOLERAE	65		
LEPTOSPIRACANICOLA - INFECTIOUS JAUNDICE	60		
SALMONELLA TYPHOSA - TYPHOID FEVER	41		
SHIGELLA DYSETERIAE - DYSENTERY	42		
SHIGELLA FLEXNERI - DYSENTERY	34		

*The dose is the radiation density multiplied by the time (t) in seconds and expressed in joules per square meter (J/m²), (1 joule is equal to 1Wsecond).

UVLOGIKA SYSTEM RANGE

GERMICIDAL UV-C LAMP



UV-C RAYS FOR SANITISING SURFACES

We live surrounded by microorganisms:

bacteria, viruses, molds, enzymes and protozoa.

Places heavily frequented every day, such as offices, schools, waiting rooms, etc., require periodic sanitising treatments for a massive contrast of any vegetative, bacterial or viral form.

The surface sanitisation by UV-C rays is the most efficient and in full respect of the environment, being ozone free and chemicals free system.

Germicidal ultraviolet radiation is indeed

a safe and effective technology, which replicates, by intensifying it, the natural purifying action of solar radiation, reducing or eliminating any contaminants in premises where we stay for most of the day.

Thanks to UV-C rays, the nuclei of the cells of microorganisms undergo a photolytic alteration that changes their DNA or RNA and makes them harmless and no longer replicable, thus avoiding the spread of infections, diseases or damage.

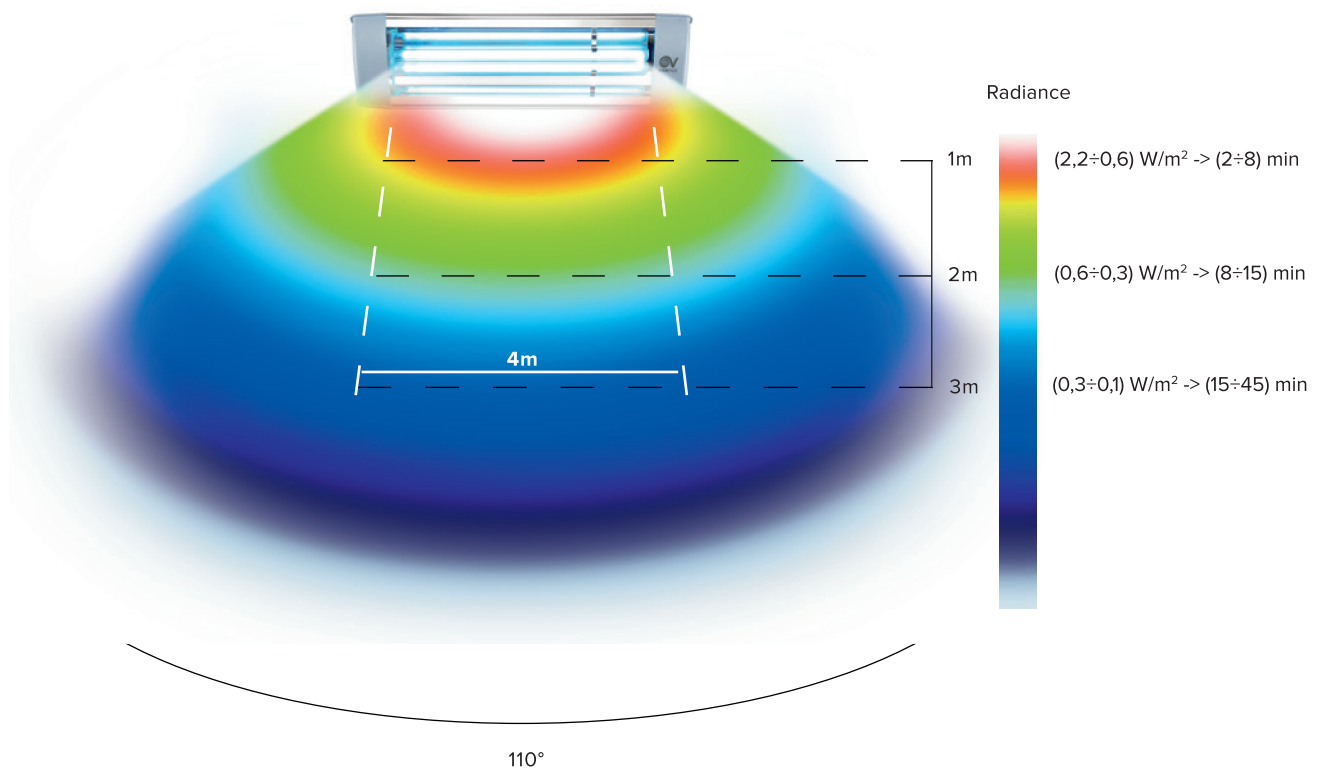

THE IMAGE ABOVE REPRESENTS THE IRRADIANCE, THE DISTANCE FROM THE SURFACE AND THE CLEANING TIMES OF UVLOGIKA SYSTEM.

EXAMPLES OF ROOM SANITISATION

The images below represent the distribution of the intensity of the UV-C radiation emitted by UVLOGIKA SYSTEM in different situations, by type of installation (ceiling or wall), by installation height (1, 2 or 3 meters) and by number of UVLOGIKA SYSTEMS installed (1 or 3).

Ceiling installation examples 1 UVLOGIKA SYSTEM

01

Installation height: 1 m.
Covered area: 3 m².
Max. irradiance: 2.2 W/m².
Sanitisation time for killing 99% of bacteria and viruses: 2 - 8 minutes.

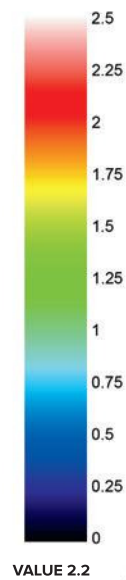
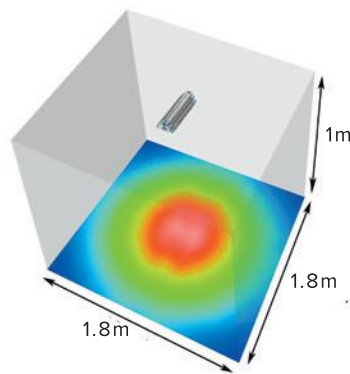

02

Installation height: 2 m.
 Covered area: 6 m².
 Max. irradiance: 0.63 W/m².
 Sanitisation time for killing 99% of bacteria and viruses: 8 - 15 minutes.

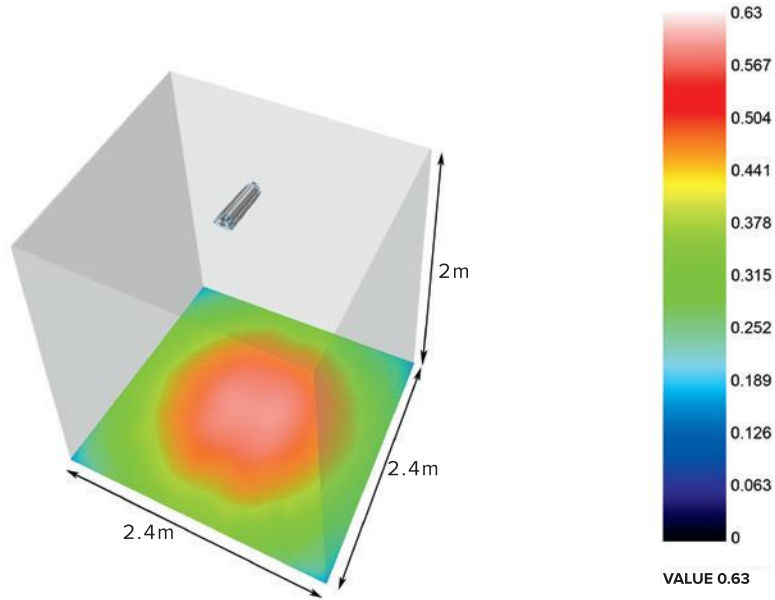

03

Installation height: 3 m.
 Covered area: 16 m².
 Max. irradiance: 0.28 W/m².
 Sanitisation time for killing 99% of bacteria and viruses: 15 - 45 minutes.

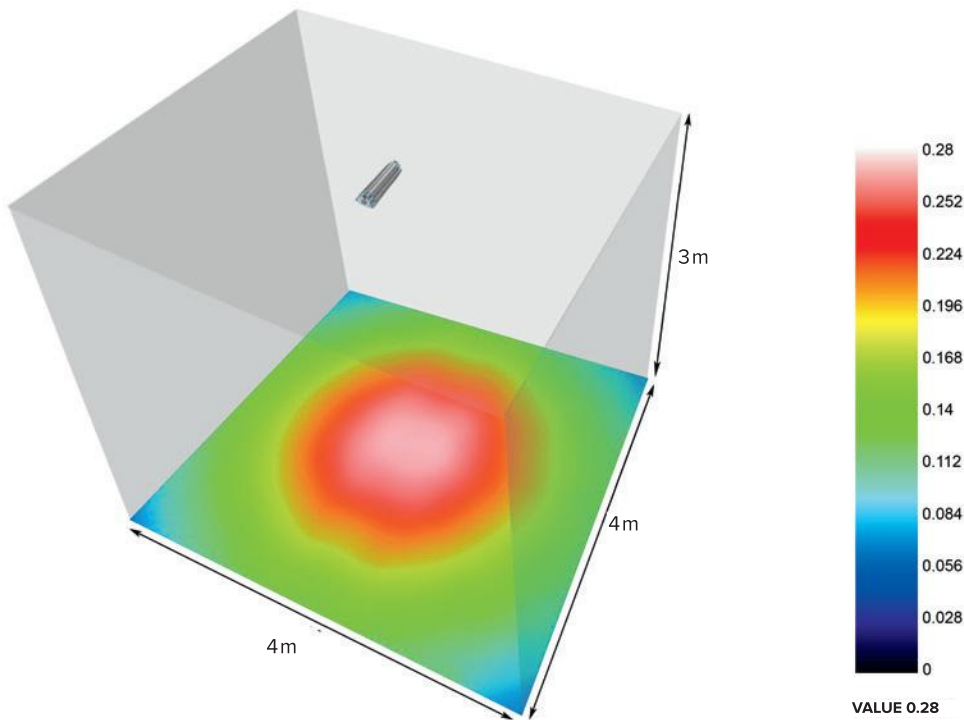

Wall installation examples 1 UVLOGIKA SYSTEM

04

Installation height: 3 m.
Covered area: 6 m².
Max. irradiance: 0.3 W/m² *.
Sanitisation time for killing 99% of bacteria and viruses: 15- 45 minutes.

**This value is due to the front wall distance (1,5 mt) and to the inclination of the lamp. In this position the rays are not perpendicular as for ceiling installation.*

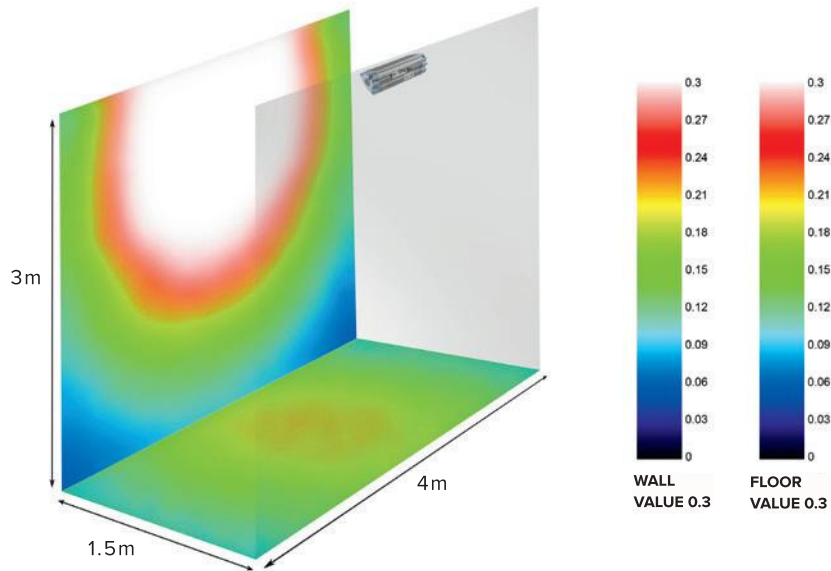

05

Installation height: 3 m.
Covered area: 10 m².
Max. irradiance: 0.3 W/m² *.
Sanitisation time for killing 99% of bacteria and viruses: 25- 45 minutes.

**Same value of irradiance of case n. 04 . But due to increased distance from the front wall (2,5 mt) the minimum sanitisation time is increased to 25 min.*

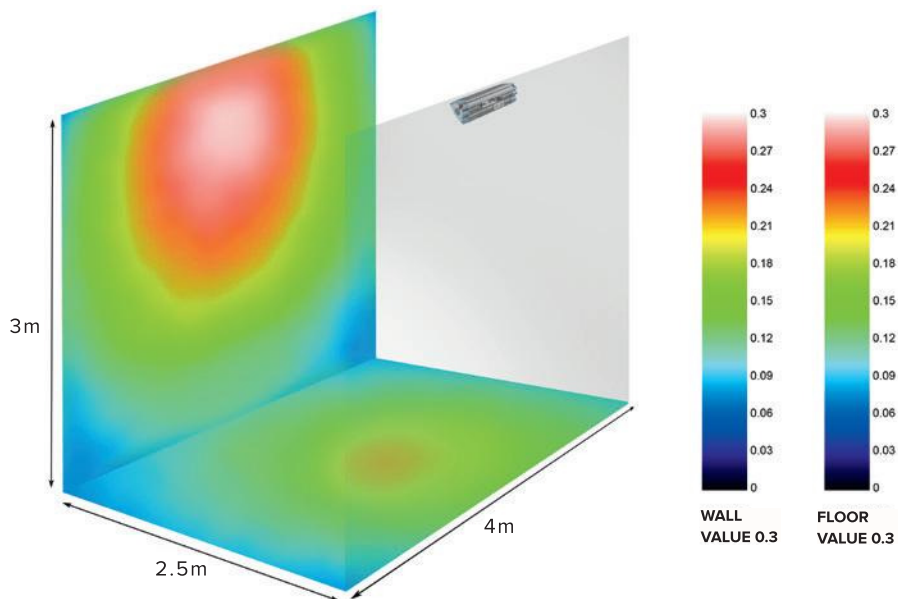



Ceiling installation example 3 UVLOGIKA SYSTEM spaced 2.4 m apart

06

Installation height: 2 m.
Covered area: 60 m².
Max. irradiance: 0.6 W/m².
Sanitisation time for killing 99% of bacteria and viruses: 8 - 45 minutes.

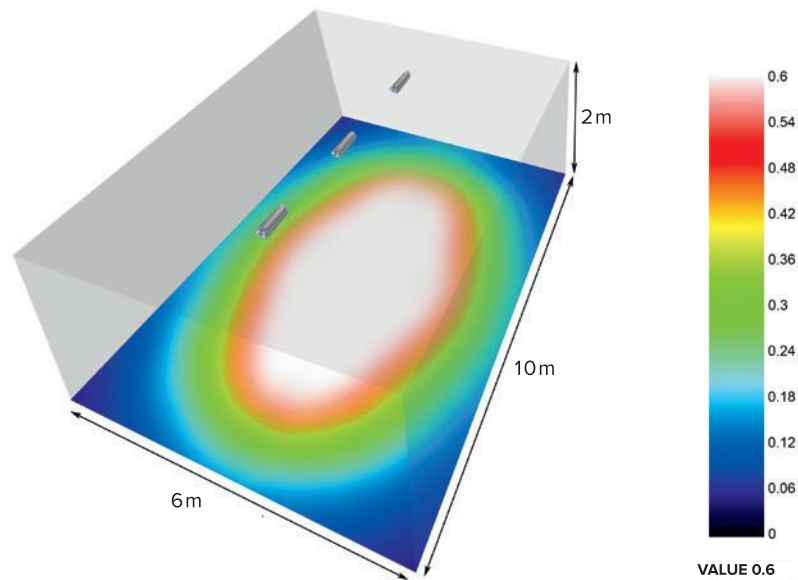

Ceiling installation example 3 UVLOGIKA SYSTEM spaced 4 m apart

07

Installation height: 3 m.
Covered area: 96 m².
Max. irradiance: 0.3 W/m².
Sanitisation time for killing 99% of bacteria and viruses: 15 - 45 minutes.

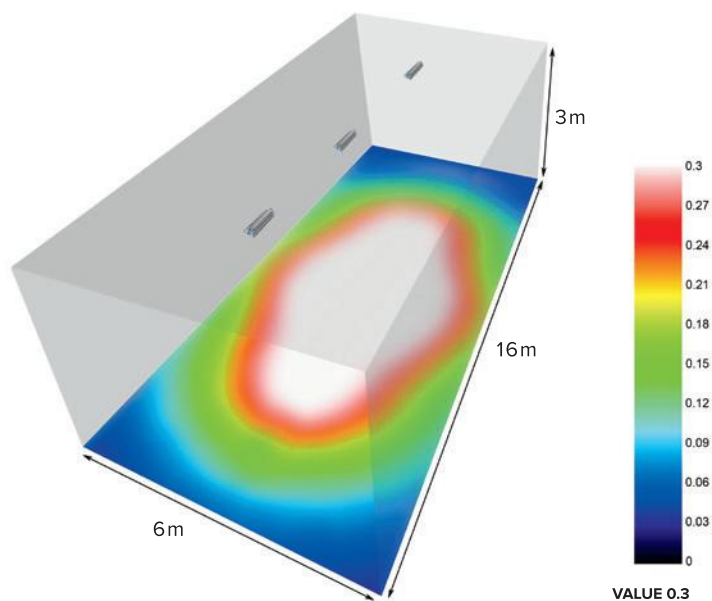



UVLOGIKA SYSTEM RANGE
GERMICIDAL UV-C LAMP

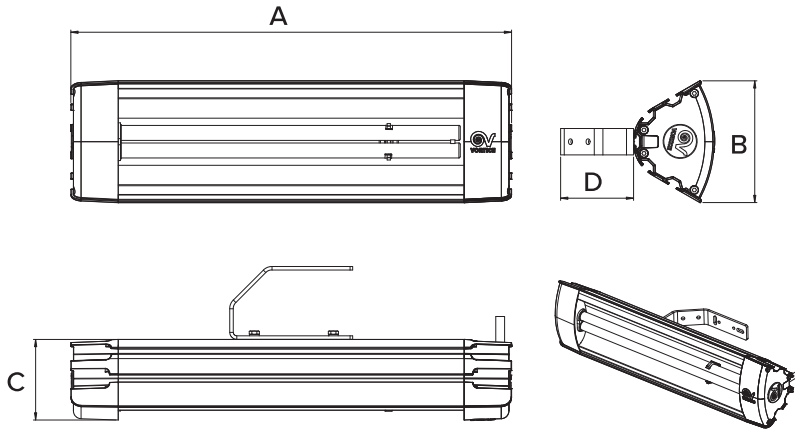

Dimensions



PRODUCT	A	B	C	D	KG
UVLOGIKA SYSTEM	502	138	92	83	2.3

Dimensions in mm





Sensors on request

	DESCRIPTION	CODE
	<p>PIR SYSTEM Presence sensor, specifically designed for its combination with UVLOGIKA SYSTEM, with which it shares the geometry of the casing for an ideal aesthetic integration in the room. Enables the effective and safe use of UVLOGIKA SYSTEM in busy areas. The sensor detects the presence of people or animals and automatically switches off the connected products, thus avoiding the risks associated with exposure to UV-C radiation. Once the area is clear again, after a safety period which can be set at installation in the 3'- 20' range, PIR SYSTEM automatically restarts the products.</p> <p>PIR SYSTEM can manage up to 10 UVLOGIKA SYSTEMS simultaneously, considering the installation constraints indispensable to prevent the risks deriving from exposure to UV-C radiation.</p> <p>Where suggested by space constraints and/or the need to simplify the system, PIR SYSTEM can be tied to UVLOGIKA SYSTEM using the devices supplied or, by means of the SR SYSTEM KIT, be interposed between two products. In both cases, using a single connection to the electricity grid.</p> <p>Single phase power supply 220-240 V ~ 50/60 Hz. Maximum permissible load: 3 A. Dimensions: 140x 178 x 100 mm</p>	13049
	<p>C PIR Sensor for controlling the presence of people in the environment: enables the effective and safe use of UVLOGIKA SYSTEM in busy areas. The sensor detects the presence of people or animals and automatically switches off the connected product, thus avoiding the risks associated with exposure to UV-C radiation. Once the area is clear again, after a safety period which can be set at installation in the 3'- 20' range, C PIR automatically restarts the product.</p> <p>Single phase power supply 220-240 V ~ 50/60 Hz. Maximum permissible load: 3 A. Dimensions: 54 x 144 x 55.8 mm</p>	12998

NB: By installing the PIR SYSTEM or the C PIR at a height of 2.25m, both VORTICE sensors detect the presence laterally up to 2.25m both on the right and on the left, while on the front up to 4m.

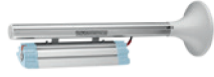

Accessories on request

	DESCRIPTION	CODE
	<p>SR SYSTEM KIT Enables the installation of 2 UVLOGIKA SYSTEMS side by side.</p> <p>The kit includes: 1 wall bracket, which replaces the wall fixing brackets supplied as standard with each appliance and 1 junction box for the simultaneous power supply of the two appliances through a single network connection.</p> <p>Dimensions: 142 x 460 x 88 mm</p>	<p>21460</p>
	<p>KIT FN1 SYSTEM Kit for horizontal installation on the ceiling of 1 UVLOGIKA SYSTEM.</p> <p>The kit includes: 1 plate for ceiling mounting and 1 stainless steel cable, 2 meters long.</p> <p>Dimensions: 100÷500 x 144 x 14.5 mm</p>	<p>21495</p>
	<p>KIT FN2 SYSTEM Kit for horizontal installation on the ceiling of 1 UVLOGIKA SYSTEM.</p> <p>The kit includes: 2 plates for ceiling mounting and 1 stainless steel cable, 2 meters long.</p> <p>Dimensions: 100÷500 x 250÷300 x 60 mm</p>	<p>21496</p>
	<p>MTB SYSTEM Kit for horizontal installation on the wall of UVLOGIKA SYSTEM.</p> <p>The kit includes the wall fixing plate that contains the connection to the electrical grid.</p> <p>Dimensions: 150÷225 x 800x 64 mm</p>	<p>21497</p>
	<p>STB SYSTEM Kit for vertical installation on the ceiling of 1, 2 or 3 UVLOGIKA SYSTEMS.</p> <p>The kit includes the wall fixing plate that contains the connection to the electrical grid of all the connected devices.</p> <p>Dimensions: 500 x 240 x 245 mm</p>	<p>21498</p>

FAQ

Is UVLOGIKA SYSTEM effective against COVID-19?

The "ISS COVID-19 Report • no. 5/2020 Rev. 2. Interim indications for the prevention and management of indoor environments in relation to the transmission of the SARS-CoV-2 virus infection", drawn up by the Italian Higher Institute of Health, states: "although it is not currently proven that the transmission of the virus derives directly from contact with commonly used objects on which it has landed, there is evidence that viruses belonging to the same group (coronavirus, SARS virus and MERS virus) can persist on inanimate surfaces up to 9 days depending on the material, the quantity of biological fluid and the initial viral concentration, the air temperature (e.g. at a temperature above 30 °C persistence is lower) and relative humidity, even if, to date, its infectious capacity has not been demonstrated. More recent data relating to the SARS-CoV-2 virus confirm that on plastic and stainless steel, in experimental conditions, the virus shows a similar persistence as the SARS virus (SARS-CoV1), however showing an exponential decay of the viral titre over time (half of the viral particles were no longer infectious after just over an hour). Under controlled laboratory conditions (e.g. with a relative humidity rate of 65%), the virus appears to be detectable for periods of less than 3 hours on paper (printed materials and tissues), up to one day on wood and fabrics, two days on glass, and longer periods (4 days) on smooth surfaces such as steel and plastic, persisting up to 7 days on the external fabric of surgical masks".

The UVLOGIKA SYSTEM has a radiation intensity of 220 $\mu\text{W}/\text{cm}^2$. This value is sufficient to eliminate, in just 8 minutes of exposure, 99% of the bacteria and viruses listed below and present on a surface located 2 m from the lamp, including SARS- CoV-2.

What is ultraviolet radiation and how is it used?

The term "ultraviolet radiation" (UV) identifies the range of electromagnetic radiation invisible to the human eye, characterised by a wavelength between 100 and 400 nm (nanometers).

UV radiation is commonly divided into 3 bands, corresponding to different wavelength ranges: UV-A (400-315 nm), UV-B (315-280 nm), UV-C (280-100 nm).

The most important natural source of UV radiation is surely the sun, due to the transformation of the thermal energy produced by the chemical-nuclear reactions taking place inside and on its surface into radiant energy. Moreover, the atmosphere filters a high percentage of such radiations, which reach us after being strongly attenuated, to varying degrees depending on their type: the earth's surface is normally reached by over half of UV-A rays and by 15% 20% of UV-B rays, while almost all UV-C rays, the most dangerous for health due to their high energy content, are filtered in the upper layers of the atmosphere. It is these last types of rays, UV-C, that are classified as germicidal and virucidal.

The discovery, in the second half of the 19th century, of the sterilising properties of ultraviolet light has led to today's production of germicidal lamps, capable of emitting UV-C radiation with a wavelength of 253.7 nm, mainly used to disinfecting surfaces, sanitising water supplies and purifying air flows of harmful microorganisms.

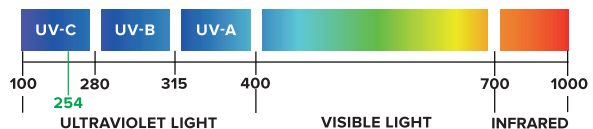

Can UVLOGIKA SYSTEM be used as a lighting device?

As with all UV-C lamps, the visible light emitted by UVLOGIKA SYSTEM is almost non-existent; in this sense, the product is not suitable for lighting purposes; similarly, chromatic gradations, color temperature or output lumens are not relevant data for this purpose.

Can UVLOGIKA SYSTEM be used for heating?

UVLOGIKA SYSTEM cannot be used to heat the air nor the irradiated bodies.

Ultraviolet light is, together with the light visible to the naked eye and the infrared radiation, one of the three components of radiation produced by thermonuclear reactions occurring in the sun and reaching the earth in the form of electromagnetic radiation. Of these three components, only the infrared one has the property of transmitting heat to the superficial layer of the skin, heating it.

What measures must be taken to ensure total safety of use of UVLOGIKA SYSTEM?

When designing the system, it is advisable to envisage, in combination with UVLOGIKA SYSTEM, protective devices such as presence detectors, timers, door locks, light signs, etc., automatically operated and in sufficient number to ensure total coverage of the environment, in order to prevent any risk of accidental exposure to UV-C rays. Similarly, the installer must size the system adequately, according to the plan and volume of the premises, as well as the number of accesses.

These precautions are necessary due to the mutagenic and carcinogenic nature of UV-C ultraviolet light, which prevents the use of UVLOGIKA SYSTEM in the presence of people or animals. The danger is however proportional to the exposure time.

Is the power of UVLOGIKA SYSTEM adjustable?

The power of the UV-C lamp of UVLOGIKA SYSTEM has been carefully studied to achieve the best balance between sanitising efficacy, constancy of the radiation wavelength, guaranteed by the transformer, and durability. For this reason, there is no dimming possibility.

Can I program the operation of UVLOGIKA SYSTEM?

UVLOGIKA SYSTEM is designed to be combined with the PIR SYSTEM and C PIR presence sensors, which manage its operation independently: UVLOGIKA SYSTEM switches itself on in the absence of people or animals in the illuminated area and switches off in their presence, turning back on only after a time that can be set at installation in the 3'-20' range.

In applications where it is possible to predict with certainty the absence of people or animals in predefined periods of the day (e.g. offices, shops, etc.) and in any case always in combination with safety devices designed to interrupt the operation of the product in case of presence of living beings within its range, **UVLOGIKA SYSTEM can also be connected to timers or other programming devices.**

What is the average life of the UV-C lamp of UVLOGIKA SYSTEM?

The life of the UV-C lamp of UVLOGIKA SYSTEM is 9,000 hours, corresponding to about 1 year of uninterrupted operation, according to the L70 standard. This value corresponds to the time within which the intensity of the emitted light remains above 70% of the nominal value.

Where can I find the replacement UV-C lamp for UVLOGIKA SYSTEM?

The UV-C lamp, as well as all spare parts for VORTICE products, can be purchased from authorised Local Distributor.

How long will the UV-C lamp of UVLOGIKA SYSTEM be available on the market?

Similarly to the other products in the VORTICE range, the availability of spare parts, as well as consumables, of UVLOGIKA SYSTEM is guaranteed for 10 years from the end of production.

What maintenance is required to ensure the correct operation of UVLOGIKA SYSTEM?

Apart from the periodic cleaning of the lamp to eliminate the accumulated dust that filters the radiation and reduces its sanitising efficacy, the correct use of UVLOGIKA SYSTEM does not require any intervention in addition to the periodic replacement of the UV-C lamp.



Do you need assistance on this product?

CONTACT OUR CUSTOMER SERVICE

pre-sales@vortice-italy.com / export@vortice-italy.com

VORTICE GROUP COMPANIES

VORTICE S.P.A

Strada Cerca, 2
Frazione di Zoate
20067 Tribiano
(Milano) Italy
Tel. (+39) 02 906991
Fax (+39) 02 90699625
vortice.com

VORTICE LIMITED

Beeches House-Eastern
Avenue Burton on Trent
DE13 0BB United Kingdom
Tel. (+44) 1283-49.29.49
Fax (+44) 1283-54.41.21
vortice.ltd.uk

VORTICE INDUSTRIAL S.R.L.

Via B. Brugnoli 3,
37063 Isola della Scala
(Verona) Italy
Tel. (+39) 045 6631042
Fax (+39) 045 6631039
vorticeindustrial.com

CASALS VENTILACIÓN AIR INDUSTRIAL S.L.

Ctra. Camprodon, s/n 17860
Sant Joan de les Abadesses
(Girona) Spain
Tel. (+34) 972720150
casals.com

VORTICE LATAM S.A.

Bodega #6
Zona Franca Este Alajuela,
Alajuela 20101
Costa Rica
Tel. (+506) 2201 6934
vortice-latam.com

VORTICE VENTILATION SYSTEM

(Changzhou) Co.LTD
No. 388 West Huanghe Road
Building 19, Changzhou
Post Code: 213000 China
Tel. (+86) 0519 88990150
Fax (+86) 0519 88990151
vortice-china.com

The descriptions and illustrations in this catalog are intended to be indicative and not binding. Without prejudice to the essential characteristics of the products described and illustrated here, VORTICE reserves the right to make, at any time and without notice, any changes to parts, aesthetic details or supply of accessories to its products that are deemed to be appropriate for improvement or for any construction or commercial requirement. This printout completely cancels and replaces all previous ones.

